

Vibra Shake™ Dust Collector

Models VS-550, -1200, -1500, -2400, -3000

A self-cleaning collector that is best for intermittent applications where high collection efficiency is essential, such as reclaiming precious metals.

- Two-stage cartridge for high-efficiency filtration on both coarse and fine dusts.
- Compact, self-contained collector design allows placement flexibility and saves floor space.
- Preassembled for easy, low-cost installation—no need for compressed air.
- Selection of inlet size and location for installation flexibility.
- Recirculates filtered air saving heating and cooling costs.
- Productivity increases and morale improves by providing a cleaner working environment.
- Reduces plant maintenance costs.



VS-550

Vibra Shake cartridge features patented Pleatloc™ corrugation that assures uniform pleat spacing for better self-cleaning and longer filter life.

- Filter screen captures coarse and fibrous particles.
- Submicron particulates pass through the filter screen and are trapped by the inner layer of media.
- Galvanized outer liner protects filter media.
- Easy filter changeout for quicker maintenance.



Vibra Shake Collector

Operational Explanation

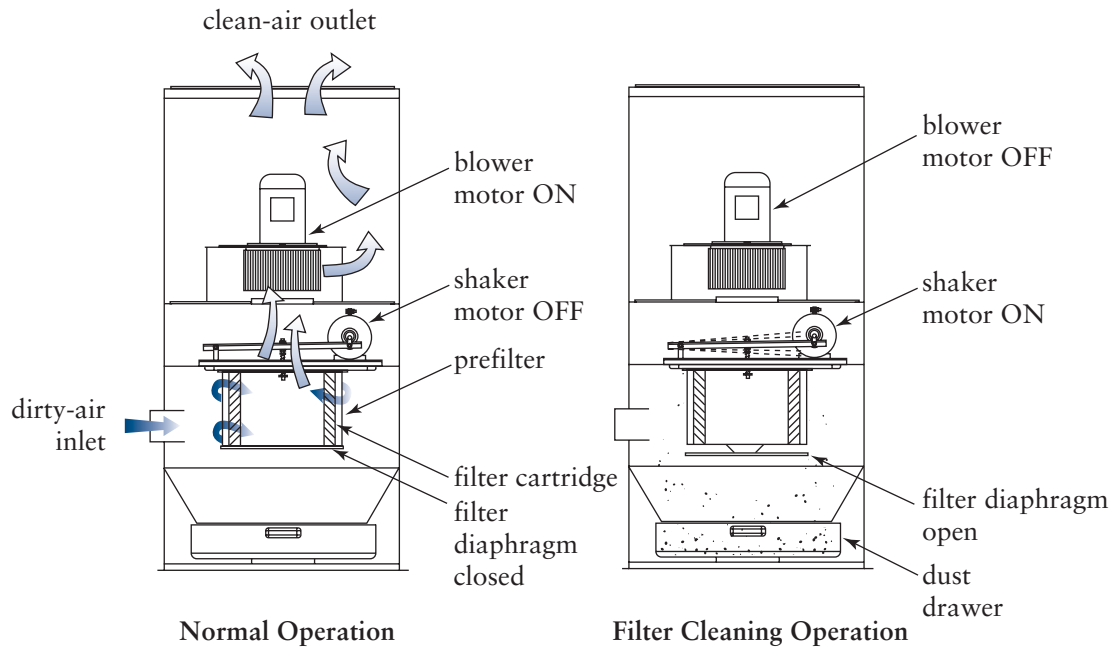

Automatic mechanical self-cleaning ensures the filter cartridge is cleaned every time the unit is shut off. It does an excellent job more cost effectively, and it does it quietly because of heavy-duty construction, special sound-attenuating material, and a vibration isolation motor mount.

Multiple Rating Table

Model	Nominal Airflow* (cfm)	Motor (hp)	Inlet (inches)	External Static Pressure ("wg)
VS-500	550	1	4	4.3
	500	1	4	4.3
	450	1	4	4.6
	400	1	4	4.7
VS-1200	1243	3	6	4.8
	1100	3	6	5.8
	1000	3	6	6.2
	800	3	6	7.2
	700	3	6	7.5
VS-1500	1525	5	7	3.0
	1447	5	7	3.6
	1348	5	7	4.2
	1200	5	7	5.2
	1000	5	7	6.0

Model	Nominal Airflow* (cfm)	Motor (hp)	Inlet (inches)	External Static Pressure "wg
VS-2400	2400	5	8	5.7
	2200	5	8	6.2
	2000	5	8	6.7
	1800	5	8	7.0
	1600	5	8	7.2
	1400	5	8	7.4
VS-3000	3300	7.5	10	4.4
	3000	7.5	10	5.2
	2800	7.5	10	5.8
	2600	7.5	10	6.6
	2400	7.5	10	7.1
	2200	7.5	10	7.6
	2000	7.5	10	8.0
	1800	7.5	10	8.2

* Based on clean filters.

Vibra Shake Collector

Dimensions & Specifications

Model	Nominal Airflow* (cfm)	Filter Area (ft ²)	Dust Drawer Volume (cu ft)	Shipping Weight Dust Drawer (lbs)	Shipping Weight Hopper (lbs)	Sound Level dB(A)**
VS-550	550	65	1.8	350	490	69
VS-1200	1200	135	1.8	370	510	74
VS-1500	1500	177	1.8	385	525	79
VS-2400	2400	270	3.6	685	960	81
VS-3000	3000	354	776	1050	83	

* Based on clean filters.

** Published dB(A) sound levels are for units without HEPA filter and are an overall average. This average is determined for one operating condition and in a controlled laboratory environment. Actual installed equipment sound levels will vary depending on the measurement location, the operating condition, the installation, and the environment.

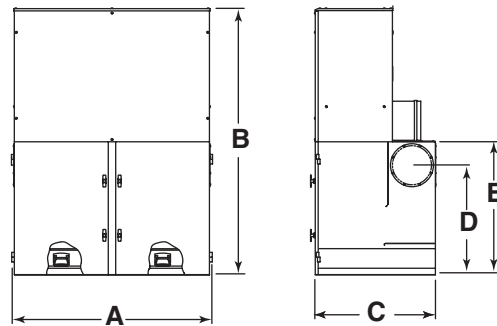
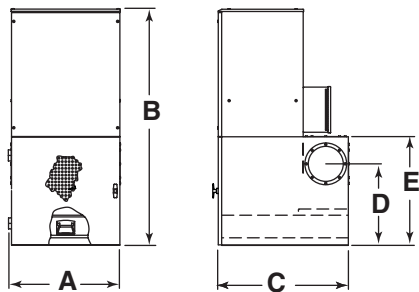
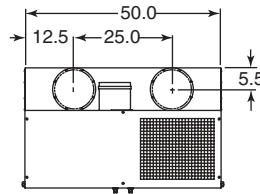
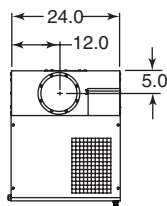

VS-550, 1200 and 1500 Dust Drawer

VS-2400 and 3000 Dust Drawer

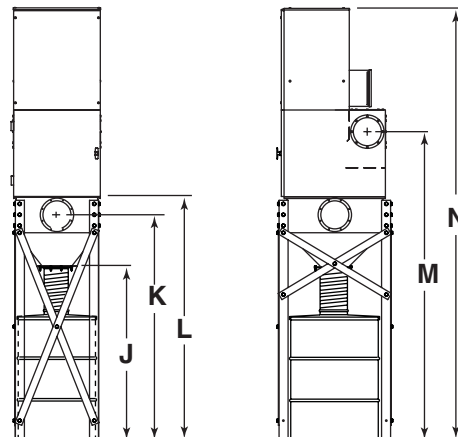
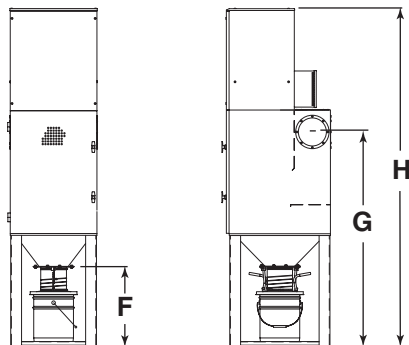

5-Gallon Pail
VS-550, 1200, and 1500 Only

Hopper and 55-Gallon Drum
All Models

Model	Dimensions (inches)												
	A	B	C	D	E	F	G	H	J	K	L	M	N
VS-550	24.7	52.2	30.8	18.1	24.1	22.3	49.5	83.7	48.0	62.3	67.3	85.3	119.4
VS-1200	24.7	62.2	30.8	28.1	34.1	22.3	59.3	93.7	48.0	62.3	67.3	101.4	129.4
VS-1500	24.7	68.2	30.8	34.1	40.1	22.3	65.5	99.7	48.0	62.3	67.3	107.4	135.4
VS-2400	51.3	69.2	33.0	28.1	34.2	--	--	--	48.0	--	--	103.6	144.7
VS-3000	51.3	75.2	33.0	34.1	40.1	--	--	--	48.0	--	--	109.6	150.7

Vibra Shake Collector

Standard Features & Equipment Options

	Standard	Optional		Standard	Optional
Collector Design					
Integral Fan Housing with Motor	X				
Shaker Motor 1/8 hp, 115/60/1 TENV	X				
Inlet Collar	X				
Hinged Cartridge Access Door	X				
Prewired Cleaning Control NEMA 12	X				
Prewired Starter Controls		X			
Louver Pack		X			
Casters		X			
Outriggers with 4-in. Casters (VS-550-1500)		X			
Silencers (VS-2400 and VS-3000)		X			
Extraction Arm		X			
Cartridge Filters					
Two-Stage Filtration	X				
HEPA Afterfilters		X			
Paint System					
Prime Coated Interior			X		
Blue Exterior Finish Coating Meets 250-Hour Salt Spray Corrosion Protection Test			X		
Custom Color				X	
Hostile Environment Coating				X	
Epoxy Coating				X	
Hopper Discharge					
Dust Drawer Base			X		
5-Gallon Pail Pack with and without Gate				X	
55-Gallon Drum Arrangement with and without Gate (does not include drum)				X	
Slide Gate				X	
Electrical Controls, Gauges and Enclosures					
Magnehelic®* Gauge				X	
Warranty					
10-Year Warranty			X		

* Magnehelic is a registered trademark of Dwyer Instruments, Inc.



Donaldson Company, Inc.
Industrial Air Filtration
P.O. Box 1299
Minneapolis, MN 55440
Tel 800-365-1331(USA)
Tel 800-343-3639 (within Mexico)
dustmktg@mail.donaldson.com
www.donaldsontorit.com

Significantly improve the performance of your collector with genuine Donaldson Torit replacement filters and parts.

Visit us at www.donaldsondynamic.com

Information in this document is subject to change without notice.

© 1998 Donaldson Co., Inc.
Printed in U.S.A. on recycled paper

Data Sheet Vibra Shake (10/05)

